

STEP

STEP SPECIAL

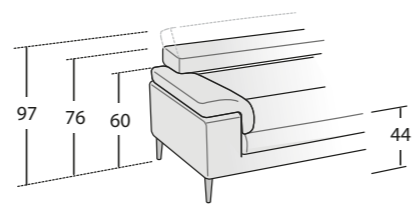

Possibilità • Possibility

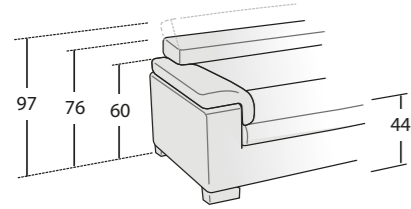
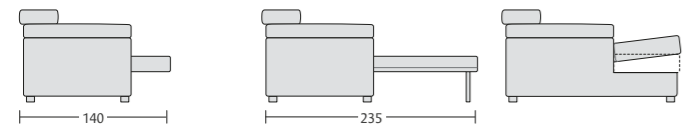

Divano con seduta estraibile aperta Divano letto aperto Elementi contenitore

Finitura a bottoni su cuscino seduta e poggiatesta

Possibilità • Possibility

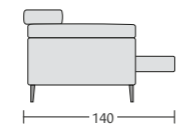

Divano con seduta estraibile aperta Versione letto e contenitore non disponibile

Finitura a bottoni su cuscino seduta e poggiatesta

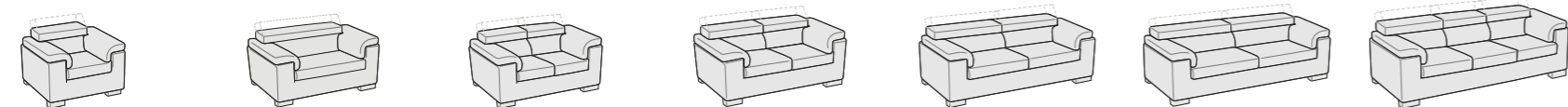

Poltrona L 108 P 105 H 76/97 • Seduta estraibile
Divano con seduta unica L 155 P 105 H 76/97 • Seduta estraibile • Letto
Divano L 155 P 105 H 76/97 • Sedute estraibili • Letto
Divano L 175 P 105 H 76/97 • Sedute estraibili • Letto
Divano L 195 P 105 H 76/97 • Sedute estraibili • Letto
Divano L 215 P 105 H 76/97 • Sedute estraibili • Letto
Divano L 245 P 105 H 76/97 • Sedute estraibili • Letto

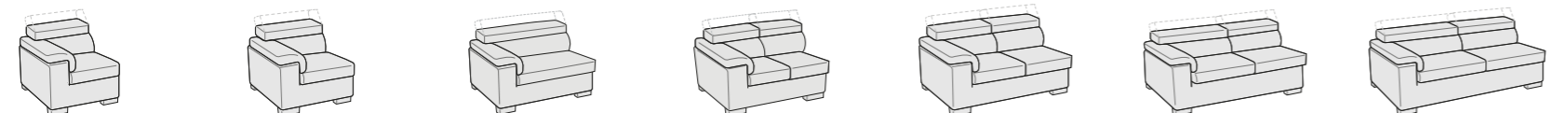

Poltrona laterale dx/sx L 89 P 105 H 76/97 • Seduta estraibile
Poltrona maxi laterale dx/sx L 99 P 105 H 76/97 • Seduta estraibile
Divano laterale seduta unica dx/sx L 136 P 105 H 76/97 • Seduta estraibile • Letto
Divano laterale dx/sx L 136 P 105 H 76/97 • Sedute estraibili • Letto
Divano laterale dx/sx L 156 P 105 H 76/97 • Sedute estraibili • Letto
Divano laterale dx/sx L 176 P 105 H 76/97 • Sedute estraibili • Letto
Divano laterale dx/sx L 196 P 105 H 76/97 • Sedute estraibili • Letto

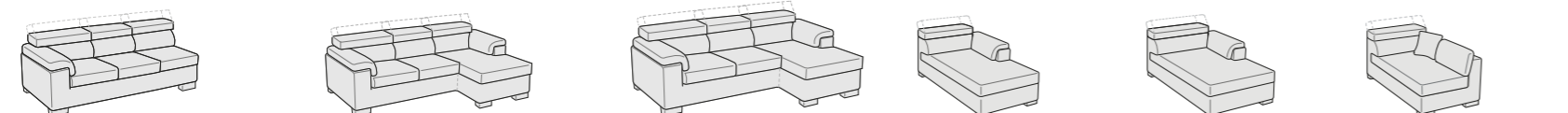

Divano laterale dx/sx L 226 P 105 H 76/97 • Sedute estraibili • Letto
Componibile panchetta reversibile L 230 P 160 H 76/97 • Letto
Componibile panchetta reversibile L 245 P 160 H 76/97 • Letto
Panchetta dx/sx L 98 P 160 H 76/97 • Contenitore
Panchetta maxi dx/sx L 108 P 160 H 76/97 • Contenitore
Penisola angolare dx/sx BR23 L 102 P 185 H 76/97 BR15 L 94 P 185 H 76/97 • Contenitore



Penisola angolare dx/sx BR23 L 102 P 205 H 76/97 BR15 L 94 P 205 H 76/97 • Contenitore
Penisola angolare relax motorizzata dx/sx BR23 L 102 P 238 H 76/97 BR15 L 94 P 238 H 76/97
Penisola angolare c/pouff dx/sx BR23 L 102 P 218 H 76/97 BR15 L 94 P 218 H 76/97
Penisola angolare c/pouff dx/sx BR23 L 102 P 238 H 76/97 BR15 L 94 P 238 H 76/97
Angolo penisola dynamic c/pouff dx/sx L 105 P 220 H 76/97 • 3 poggiatesta reclinabili
Angolo retto dynamic L 105 P 105 H 76/97 • 2 poggiatesta reclinabili



Angolo retto dynamic dx/sx L 105 P 140 H 76/97 • 2 poggiatesta reclinabili
Angolo aperto L 130 P 130 H 76
Pouff L 80 P 60 H 44 L 60/70/80 P 105 H 44 L 90/140 P 105 H 44 • Contenitore
Pouff mono L 75 P 75 H 42 L 95 P 95 H 42 L 115 P 115 H 42

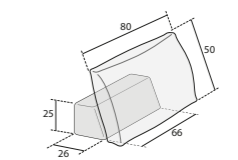

Pacchetto schiena Witty

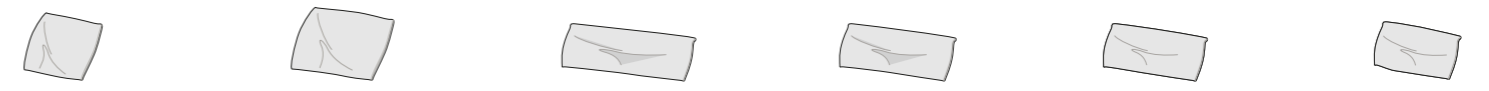

Cuscino decoro L 40x40 **Cuscino decoro** L 55x45
Cuscino poggiareni L 75x27 (divano cm 215, divano lat. cm 196, panchetta maxi)
Cuscino poggiareni L 65x27 (divano cm 195, divano lat. cm 176, poltrona maxi lat., panchetta, penisola ang. c/pouff)
Cuscino poggiareni L 55x27 (divano cm 175, divano cm 245, divano lat. cm 156, divano lat. cm 226, poltrona, poltrona lat. componibile panchetta reversibile cm 245, angolo penisola c/pouff)
Cuscino poggiareni L 45x27 (divano cm 155, divano lat. cm 136, componibile panchetta reversibile cm 226)

COMPLEMENTI: LAMPADA A LED, CARICABATTERIA WIRELESS, ACCESSORIO POP

Lampada a Led touch, pieghevole e facilmente rimovibile
Touch led lamp, foldable and easily pull-out

Caricabatteria Wireless posizionato sotto il rivestimento, per dispositivi idonei
Wireless charger under the cover, for suitable devices

Accessorio Pop antracite opaco disponibile nelle versioni:
 Pop piano, Pop caricabatteria, Pop lampada, Pop multifunzione
Pop matt anthracite accessory available in the versions: Pop top, Pop battery charger, Pop lamp, Pop multifunction

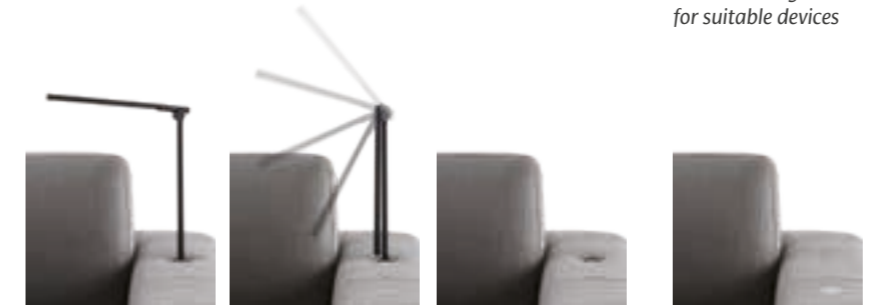

Posizione lampada a led e caricabatteria wireless su:

- bracciolo penisola angolare, penisola angolare con pouff - bracciolo penisola angolare relax

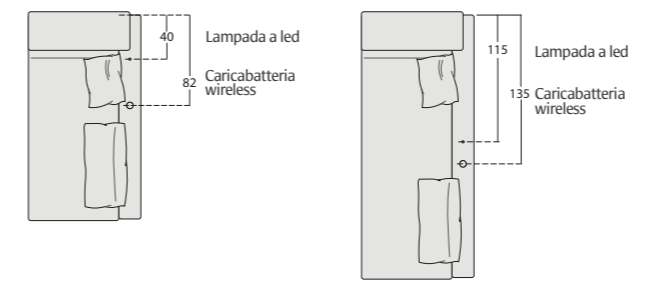

Posizione accessorio Pop su:

- angolo penisola dynamic dx/sx, angolo retto dynamic, angolo retto dynamic dx/sx

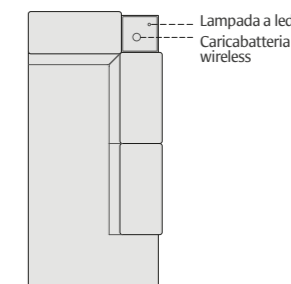

STEP



Piede in legno Brick colore nero di serie, colore beige optional.
Standard black finish wooden Brick foot, beige finish optional.

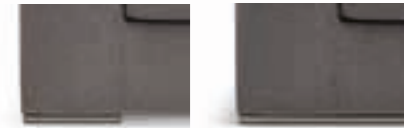

Piede in metallo
Base finitura cromo
o manganese
optional.
Chrome or
manganese finish
metal Base foot
optional.

Piede in metallo
Line finitura cromo
o manganese
optional.
Chrome or
manganese finish
metal Line foot
optional.

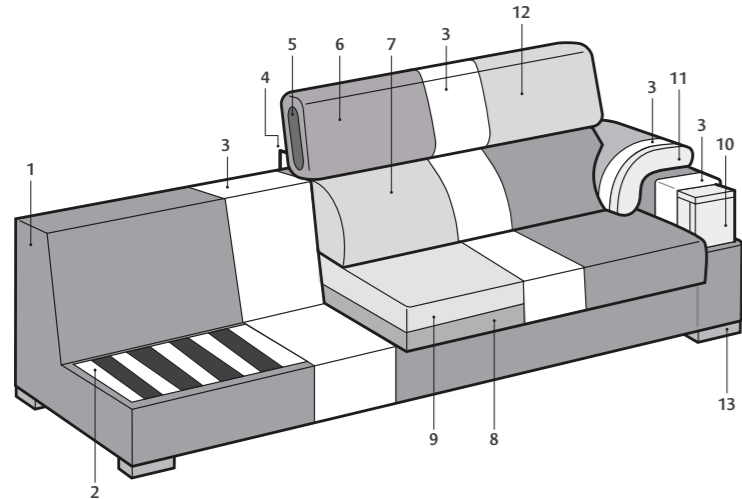

1. Struttura in legno stagionato e agglomerato • Frame in seasoned wood and agglomerated wood.
 2. Molleggio seduta nastri elastici in fibra propilenica e lattice da 80 mm tesi meccanicamente • Seat sprung in mechanically-tensioned 80-mm propylene fibre and latex webbing.
 3. Rivestimento in ovatta di poliestere gr 300 • Covered in 300 gr polyester wadding.
 4. Meccanismo cromato per movimento poggiatesta • Chromed back/headrest mechanism.
 5. Inserto in legno stagionato • Seasoned wood insert.
 6. Cuscino poggiatesta in poliuretano espanso indeformabile D 18 • Headrest cushion in non-deforming D 18 polyurethane foam.
 7. Cuscino lombare in poliuretano espanso indeformabile D 21 • Lumbar cushion in non-deforming D 21 polyurethane foam.
 8. Cuscino seduta in poliuretano espanso indeformabile D 32 • Seat cushion in non-deforming D 32 polyurethane foam.
 9. Bombatura seduta in poliuretano espanso indeformabile D 28 • Seat upholstery in non-deforming D 28 polyurethane foam.
 10. Imbottitura bracciolo in poliuretano espanso indeformabile D 40 • Armrest padding in non-deformable D40 polyurethane foam.
 11. Cuscino bracciolo in poliuretano espanso indeformabile D 21/30 • Armrest cushion in non-deformable D 21/30 polyurethane foam.
 12. Rivestimento in tessuto, pelle o ecopelle • Covered in fabric, leather or eco leather.
 13. PIEDE DI SERIE • STANDARD FOOT
 - Piede in legno Brick colore nero • Black wooden Brick foot.
- PIEDI OPTIONAL • OPTIONAL FOOT
- Piede in legno Brick colore beige • Beige wooden Brick foot.
 - Piede in metallo Base e Line finitura cromo o manganese • Chrome or manganese finish metal Base and Line foot.

STEP SPECIAL



Piede in metallo Link finitura nichel nero di serie, finitura cromo optional.
Standard black nickel finish metal Link foot, chrome finish optional.



Piede in metallo
Model finitura cromo
o manganese
optional.
Optional chrome
or manganese finish
metal Model foot.

Piede in metallo Zed
finitura cromo o
manganese
optional.
Optional chrome
or manganese finish
metal Zed foot.

Piede in metallo
Abby finitura cromo
o manganese
optional.
Optional chrome
or manganese finish
metal Abby foot.

Piede in metallo
Split finitura cromo
o manganese
optional.
Optional chrome
or manganese finish
metal Split foot.

Piede in metallo
Sky finitura cromo
o manganese
optional.
Optional chrome
or manganese finish
metal Sky foot.

Piede in metallo
Cross finitura cromo
o manganese
optional.
Optional chrome
or manganese finish
metal Cross foot.

Piede in metallo
Frame finitura grigio
o manganese
optional.
Optional grey
or manganese finish
metal Frame foot.

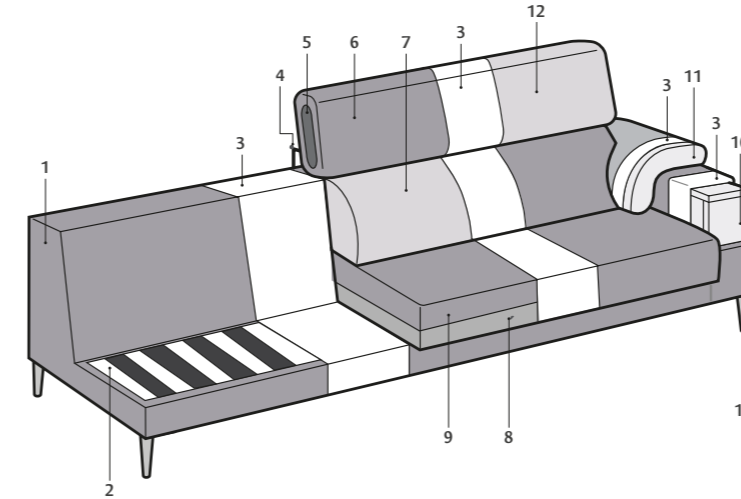

1. Struttura in legno stagionato e agglomerato • Frame in seasoned wood and agglomerated wood.
 2. Molleggio seduta nastri elastici in fibra propilenica e lattice da 80 mm tesi meccanicamente • Seat sprung in mechanically-tensioned 80-mm propylene fibre and latex webbing.
 3. Rivestimento in ovatta di poliestere gr 300 • Covered in 300 gr polyester wadding.
 4. Meccanismo cromato per movimento poggiatesta • Chromed back/headrest mechanism.
 5. Inserto in legno stagionato • Seasoned wood insert.
 6. Cuscino poggiatesta in poliuretano espanso indeformabile D 18 • Headrest cushion in non-deforming D 18 polyurethane foam.
 7. Cuscino lombare in poliuretano espanso indeformabile D 21 • Lumbar cushion in non-deforming D 21 polyurethane foam.
 8. Cuscino seduta in poliuretano espanso indeformabile D 32 • Seat cushion in non-deforming D 32 polyurethane foam.
 9. Bombatura seduta in poliuretano espanso indeformabile D 28 • Seat upholstery in non-deforming D 28 polyurethane foam.
 10. Imbottitura bracciolo in poliuretano espanso indeformabile D 40 • Armrest padding in non-deformable D40 polyurethane foam.
 11. Cuscino bracciolo in poliuretano espanso indeformabile D 21/30 • Armrest cushion in non-deformable D 21/30 polyurethane foam.
 12. Rivestimento in tessuto, pelle o ecopelle • Covered in fabric, leather or eco leather.
 13. PIEDE DI SERIE • STANDARD FOOT
 - Piede in metallo Link finitura nichel nero • Black nickel finish metal Link foot.
- PIEDI OPTIONAL / OPTIONAL FOOT
- Piede in metallo Link finitura cromo • Chrome finish metal Link foot.
 - Piede in metallo Model, Zed, Abby, Split, Sky e Cross finitura cromo o manganese • Chrome or manganese finish metal Model, Zed, Abby, Split, Sky, Cross foot.
 - Piede in metallo Frame finitura grigio o manganese • Grey or manganese finish metal Frame foot.