

WAY

WAY SPECIAL

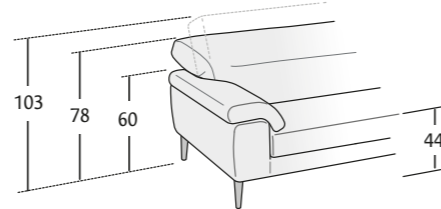

Possibilità • Possibility

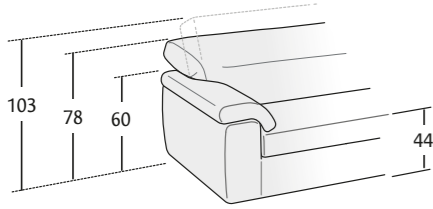
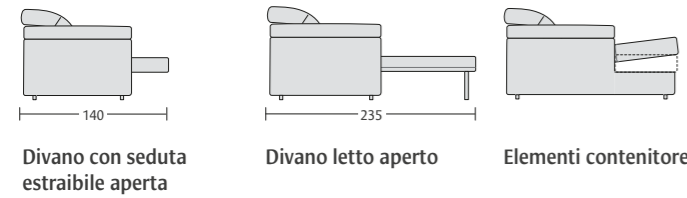

Divano con seduta estraibile aperta Divano letto aperto Elementi contenitore

Possibilità • Possibility

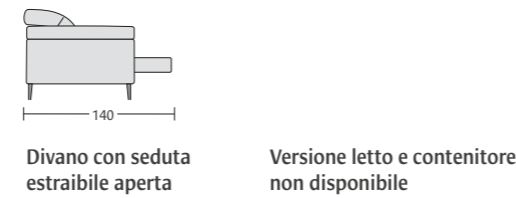

Divano con seduta estraibile aperta Versione letto e contenitore non disponibile

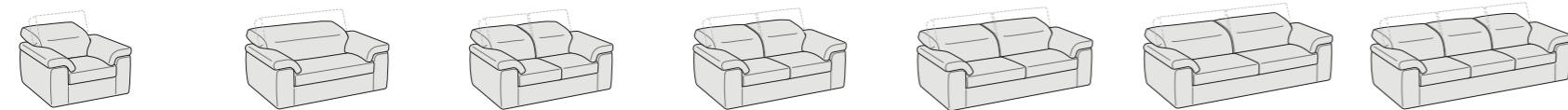

Poltrona
L 113 P 105 H 78/103
• Seduta estraibile

Divano con seduta unica
L 160 P 105 H 78/103
• Seduta estraibile
• Letto

Divano
L 160 P 105 H 78/103
• Sedute estraibili
• Letto

Divano
L 180 P 105 H 78/103
• Sedute estraibili
• Letto

Divano
L 200 P 105 H 78/103
• Sedute estraibili
• Letto

Divano
L 220 P 105 H 78/103
• Sedute estraibili
• Letto

Divano
L 250 P 105 H 78/103
• Sedute estraibili
• Letto

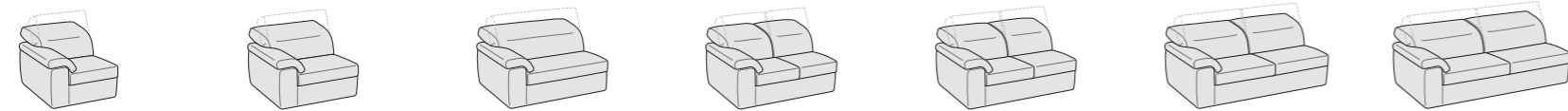

Poltrona laterale dx/sx
L 93 P 105 H 78/103
• Seduta estraibile

Poltrona maxi laterale dx/sx
L 103 P 105 H 78/103
• Seduta estraibile

Divano laterale seduta unica dx/sx
L 140 P 105 H 78/103
• Seduta estraibile
• Letto

Divano laterale dx/sx
L 140 P 105 H 78/103
• Sedute estraibili
• Letto

Divano laterale dx/sx
L 160 P 105 H 78/103
• Sedute estraibili
• Letto

Divano laterale dx/sx
L 180 P 105 H 78/103
• Sedute estraibili
• Letto

Divano laterale dx/sx
L 200 P 105 H 78/103
• Sedute estraibili
• Letto

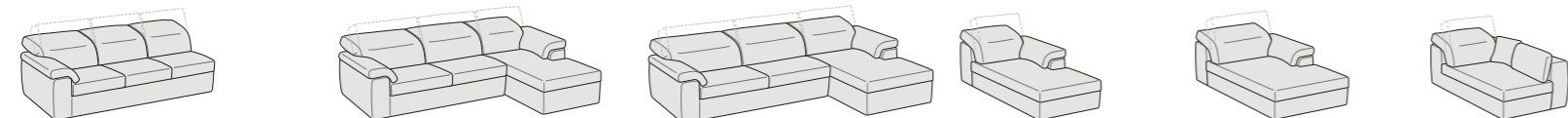

Divano laterale dx/sx
L 230 P 105 H 78/103
• Sedute estraibili
• Letto

Componibile panchetta reversibile
L 235 P 160 H 78/103
• Letto

Componibile panchetta reversibile
L 250 P 160 H 78/103
• Letto

Panchetta dx/sx
L 102 P 160 H 78/103
• Contenitore

Panchetta maxi dx/sx
L 112 P 160 H 78/103
• Contenitore

Penisola angolare dx/sx
BR26 L 106 P 185 H 78/103
BR18 L 98 P 185 H 78/103
• Contenitore

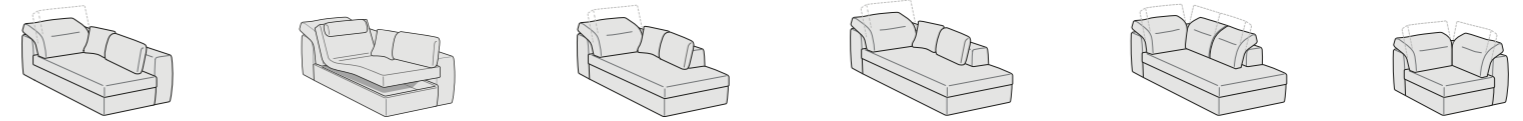

Penisola angolare dx/sx
BR26 L 106 P 205 H 78/103
BR18 L 98 P 205 H 78/103
• Contenitore

Penisola angolare relax motorizzata dx/sx
BR26 L 106 P 238 H 78/103
BR18 L 98 P 238 H 78/103

Penisola angolare c/pouff dx/sx
BR26 L 106 P 218 H 78/103
BR18 L 98 P 218 H 78/103

Penisola angolare c/pouff dx/sx
BR26 L 106 P 238 H 78/103
BR18 L 98 P 238 H 78/103

Angolo penisola dynamic c/pouff dx/sx
L 105 P 220 H 78/103
(3 poggiatesta reclinabili)

Angolo retto dynamic
L 105 P 105 H 78/103
(2 poggiatesta reclinabili)



Angolo retto dynamic dx/sx
L 105 P 140 H 78/103
(2 poggiatesta reclinabili)

Angolo aperto
L 130 P 130 H 78/103

Pouff
L 80 P 60 H 44
L 60/70/80 P 105 H 44
L 90/140 P 105 H 44
• Contenitore

Pouff mono
L 75 P 75 H 42
L 95 P 95 H 42
L 115 P 115 H 42

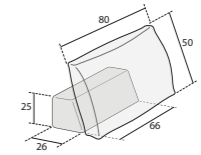

Pacchetto schiena Witty



Cuscino decoro
L 40x40

Cuscino decoro
L 55x45

Cuscino poggiatesta
L 75x27
(divano cm 220, divano lat. cm 200, panchetta maxi)

Cuscino poggiatesta
L 65x27
(divano cm 200, divano lat cm 180, poltrona maxi lat, panchetta, penisola ang., penisola ang. c/pouff)

Cuscino poggiatesta
L 55x27
(divano cm 180, divano cm 250, divano lat. cm 160, divano lat cm 230, poltrona, poltrona lat., componibile panchetta reversibile cm 250, angolo penisola c/pouff)

Cuscino poggiatesta
L 45x27
(divano cm 160, divano lat. cm 140, componibile panchetta reversibile cm 235)

COMPLEMENTI: LAMPADA A LED, CARICABATTERIA WIRELESS, ACCESSORIO POP

Lampada a Led touch, pieghevole e facilmente rimovibile
Touch led lamp, foldable and easily pull-out

Caricabatteria Wireless posizionato sotto il rivestimento, per dispositivi idonei
Wireless charger under the cover, for suitable devices

Accessorio Pop antracite opaco disponibile nelle versioni:
Pop piano, Pop caricabatteria, Pop lampada, Pop multifunzione
Pop matt anthracite accessory available in the versions:
Pop top, Pop battery charger, Pop lamp, Pop multifunction

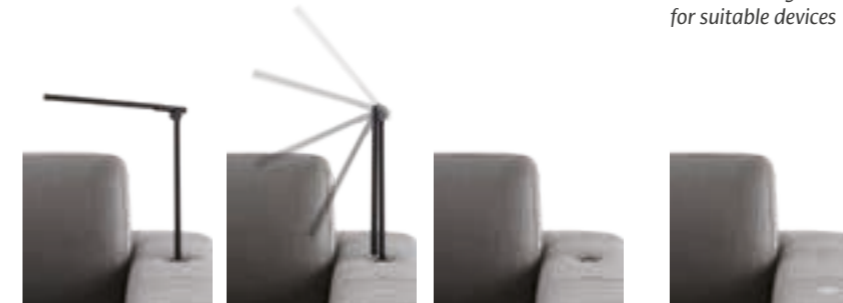

Posizione lampada a led e caricabatteria wireless su:

- bracciolo penisola angolare, penisola angolare con pouff

- bracciolo penisola angolare relax

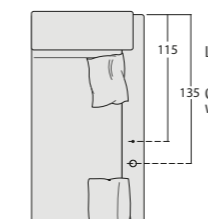
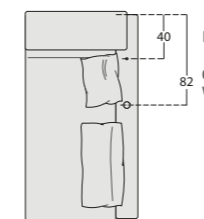

Posizione accessorio Pop su:

- angolo penisola dynamic dx/sx, angolo retto dynamic, angolo retto dynamic dx/sx

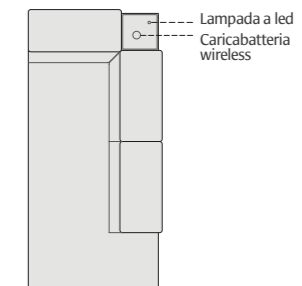

WAY



Piede in ABS effetto sospeso di serie.
Foot in ABS with suspended effect as standard.



Piede in legno Brick colore beige o nero optional.
Optional beige or black finish wooden Brick foot.

Piede in metallo Base finitura cromo o manganese optional.
Chrome or manganese finish metal Base foot optional.

Piede in metallo Line finitura cromo o manganese optional.
Chrome or manganese finish metal Line foot optional.

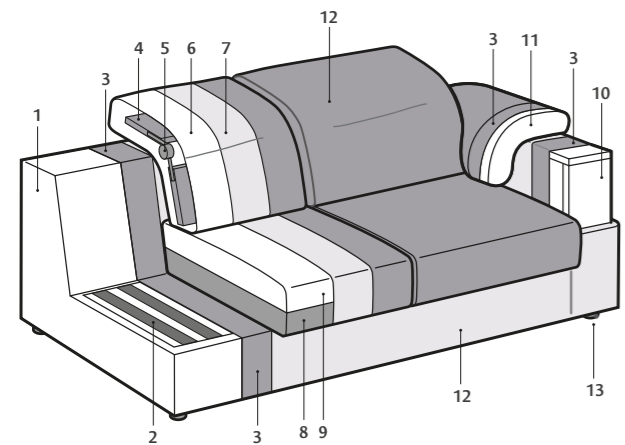

1. Struttura in legno stagionato e agglomerato • Frame in seasoned wood and agglomerated wood.
 2. Molleggio seduta nastri elastici in fibra propilenica e lattice da 80 mm tesi meccanicamente • Seat sprung in mechanically-tensioned 80-mm propylene fibre and latex webbing.
 3. Rivestimento in ovatta di poliestere gr 300 • Covered in 300 gr polyester wadding.
 4. Inserto in legno stagionato dello schienale • Backrest insert in seasoned wood.
 5. Meccanismo per movimento schienale reclinabile • Mechanism for reclining back movement.
 6. Cuscino schienale in poliuretano espanso indeformabile D 18 • Cushion in non-deforming D 18 polyurethane foam.
 7. Rivestimento in ovatta di poliestere gr 400 • Covered in 400 gr polyester wadding.
 8. Cuscino seduta in poliuretano espanso indeformabile D 32 • Seat cushion in non-deforming D 32 polyurethane foam.
 9. Bombatura seduta in poliuretano espanso indeformabile D 28 • Seat upholstery in non-deforming D 28 polyurethane foam.
 10. Imbottitura bracciolo in poliuretano espanso indeformabile D 40 • Armrest padding in non-deformable D40 polyurethane foam.
 11. Cuscino bracciolo in poliuretano espanso indeformabile D 21/30 • Armrest cushion in non-deformable D 21/30 polyurethane foam.
 12. Rivestimento in tessuto, pelle o ecopelle • Covered in fabric, leather or eco leather.
 13. PIEDE DI SERIE • STANDARD FOOT
 - Piede in ABS effetto sospeso / Foot in ABS with suspended effect.
- PIEDI OPTIONAL • OPTIONAL FOOT
- Piede in legno Brick colore beige o nero / Beige or black wooden Brick foot.
 - Piede in metallo Base e Line finitura cromo o manganese / Chrome or manganese finish metal Base and Line foot.

WAY SPECIAL



Piede in metallo Link finitura nichel nero di serie, finitura cromo optional.
Standard black nickel finish metal Link foot, chrome finish optional.



Piede in metallo Model finitura cromo o manganese optional.
Optional chrome or manganese finish metal Model foot.

Piede in metallo Zed finitura cromo o manganese optional.
Optional chrome or manganese finish metal Zed foot.

Piede in metallo Abby finitura cromo o manganese optional.
Optional chrome or manganese finish metal Abby foot.

Piede in metallo Split finitura cromo o manganese optional.
Optional chrome or manganese finish metal Split foot.

Piede in metallo Sky finitura cromo o manganese optional.
Optional chrome or manganese finish metal Sky foot.

Piede in metallo Cross finitura cromo o manganese optional.
Optional chrome or manganese finish metal Cross foot.

Piede in metallo Frame finitura grigio o manganese optional.
Optional grey or manganese finish metal Frame foot.

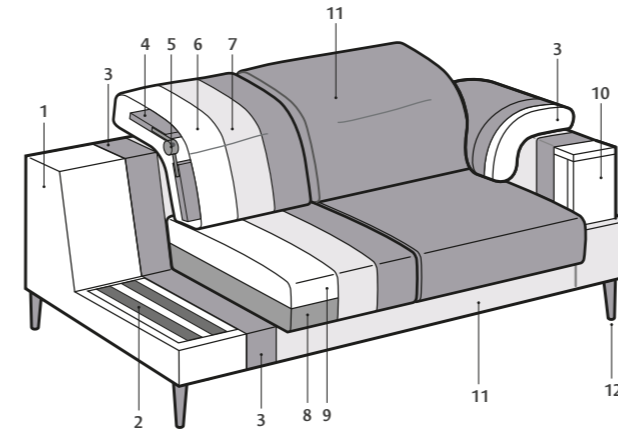

1. Struttura in legno stagionato e agglomerato • Frame in seasoned wood and agglomerated wood.
 2. Molleggio seduta nastri elastici in fibra propilenica e lattice da 80 mm tesi meccanicamente • Seat sprung in mechanically-tensioned 80-mm propylene fibre and latex webbing.
 3. Rivestimento in ovatta di poliestere gr 300 • Covered in 300 gr polyester wadding.
 4. Inserto in legno stagionato dello schienale • Backrest insert in seasoned wood.
 5. Meccanismo per movimento schienale reclinabile • Meccanismo per movimento schienale reclinabile
 6. Cuscino schienale in poliuretano espanso indeformabile D 18 • Cushion in non-deforming D 18 polyurethane foam.
 7. Rivestimento in ovatta di poliestere gr 400 • Covered in 400 gr polyester wadding.
 8. Cuscino seduta in poliuretano espanso indeformabile D 32 • Seat cushion in non-deforming D 32 polyurethane foam.
 9. Bombatura seduta in poliuretano espanso indeformabile D 28 • Seat upholstery in non-deforming D 28 polyurethane foam.
 10. Imbottitura bracciolo in poliuretano espanso indeformabile D 40 • Armrest padding in non-deformable D40 polyurethane foam.
 11. Cuscino bracciolo in poliuretano espanso indeformabile D 21/30 • Armrest cushion in non-deformable D 21/30 polyurethane foam.
 12. PIEDE DI SERIE • STANDARD FOOT
 - Piede in metallo Link finitura nichel nero • Black nickel finish metal Link foot.
- PIEDI OPTIONAL • OPTIONAL FOOT
- Piede in metallo Link finitura cromo • Chrome finish metal Link foot.
 - Piede in metallo Model, Zed, Abby, Split, Sky, Cross finitura cromo o manganese • Chrome or manganese finish metal Model, Zed, Abby, Split, Sky, Cross foot.
 - Piede in metallo Frame finitura grigio o manganese • Grey or manganese finish metal Frame foot.